



LUCASOIL.com

BASIC INSTRUCTIONS PG. 1 of 6

- PRINT OUT
- CUT OUT ALONG SOLID LINES AND THEN FOLD ON DOTTED LINES (XACTO KNIFE WORKS BEST)

STEP 1:

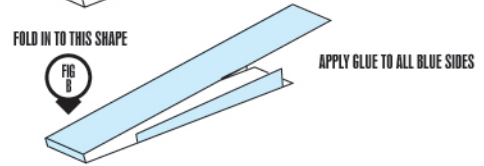
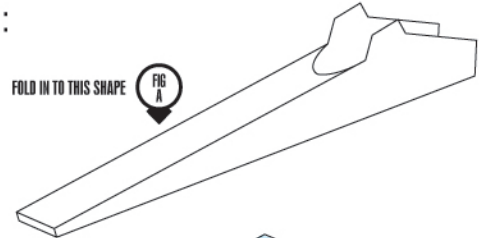

STEP 2: GLUE FIG B INTO FIG A

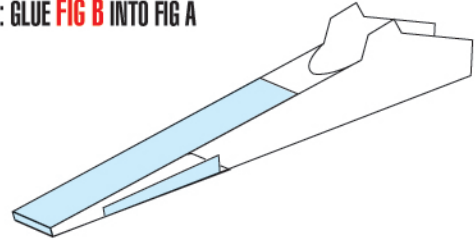

STEP 3: GLUE FIG C INTO FIG A

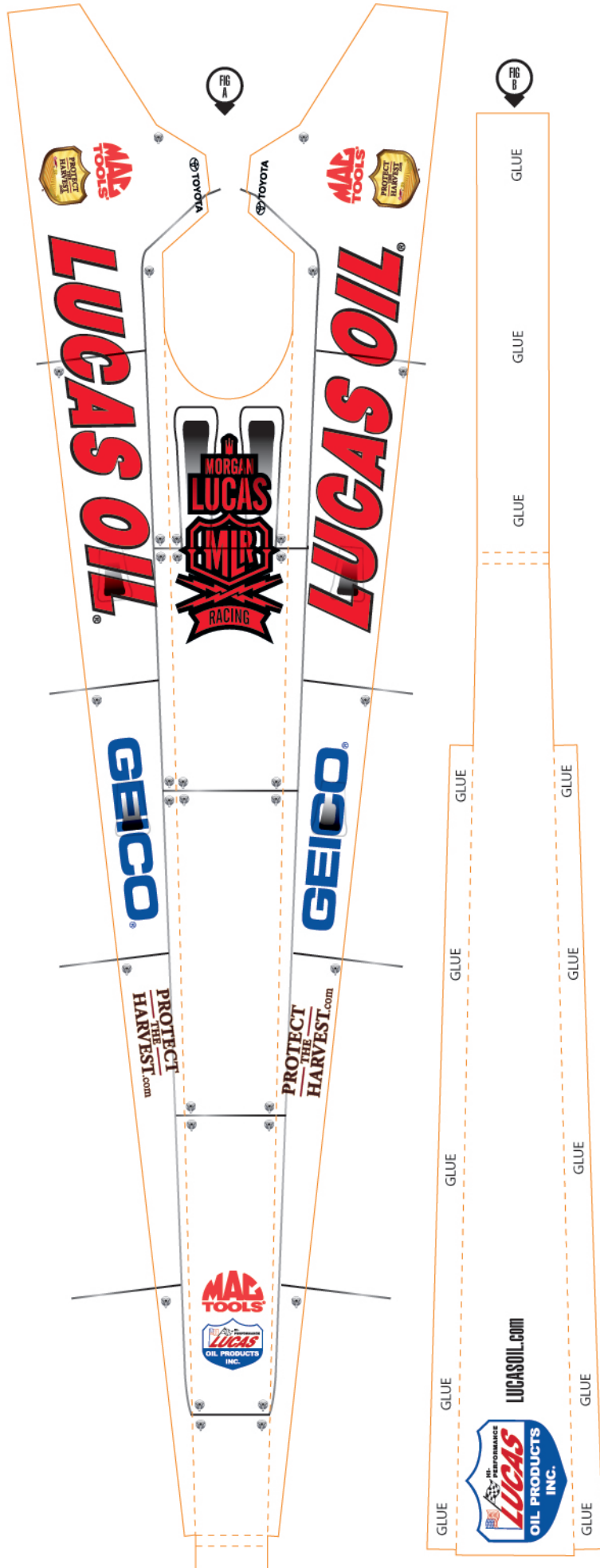
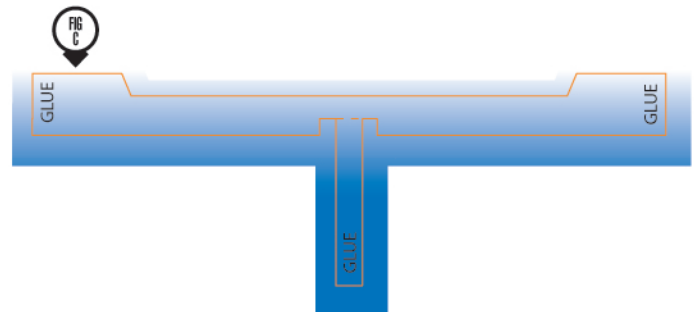
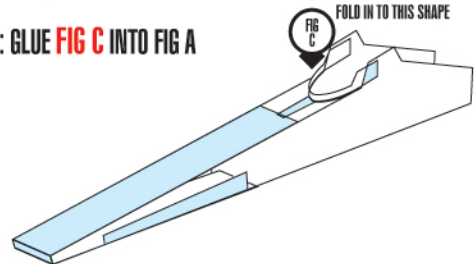

BASIC INSTRUCTIONS PG. 2 of 6

- PRINT OUT
- CUT OUT ALONG SOLID LINES AND THEN FOLD ON DOTTED LINES (XACTO KNIFE WORKS BEST)

STEP 4: FOLD AND GLUE TABS ON THE INSIDE

FOLD IN TO THIS SHAPE



APPLY GLUE TO ONE OF THE BOTTOM FLAP AND STICK TO THE OPPOSITE FLAP TO CREATE BOTTOM OF PIECE

STEP 5: GLUE FIG D INTO FIG A

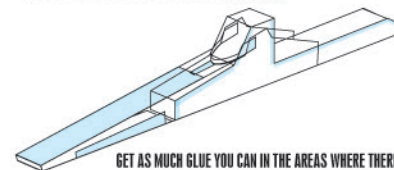

GET AS MUCH GLUE YOU CAN IN THE AREAS WHERE THERE IS THE MOST CONTACT BETWEEN BOTH PIECES. MAKE SURE FIG A AND FIG D ARE FLUSH ON THE BOTTOM. FIG D AND FIG B SHOULD COME CLOSE TO TOUCHING ON THE BOTTOM OF THE PIECE.

STEP 6:

GLUE REVERSE SIDE AND FOLD BACK

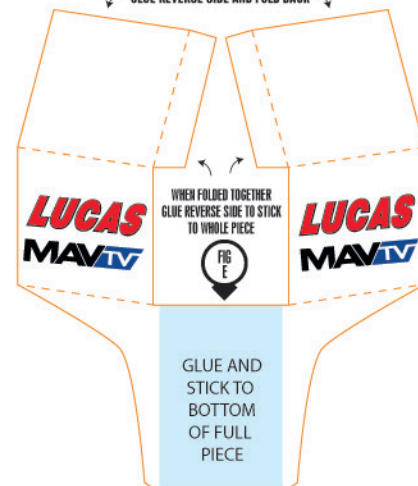

FOLD IN TO THIS SHAPE

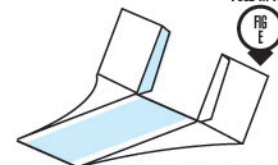

APPLY GLUE TO ALL BLUE AREAS

STEP 7: GLUE FIG E TO ASSEMBLED PARTS

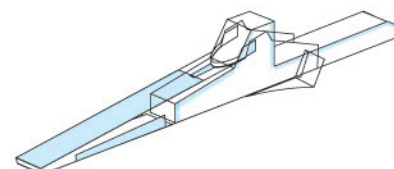

APPLY GLUE TO THIS BLUE STRIP AND STICK TO OPPOSITE SIDE TO CREATE THE BOTTOM OF THIS PIECE

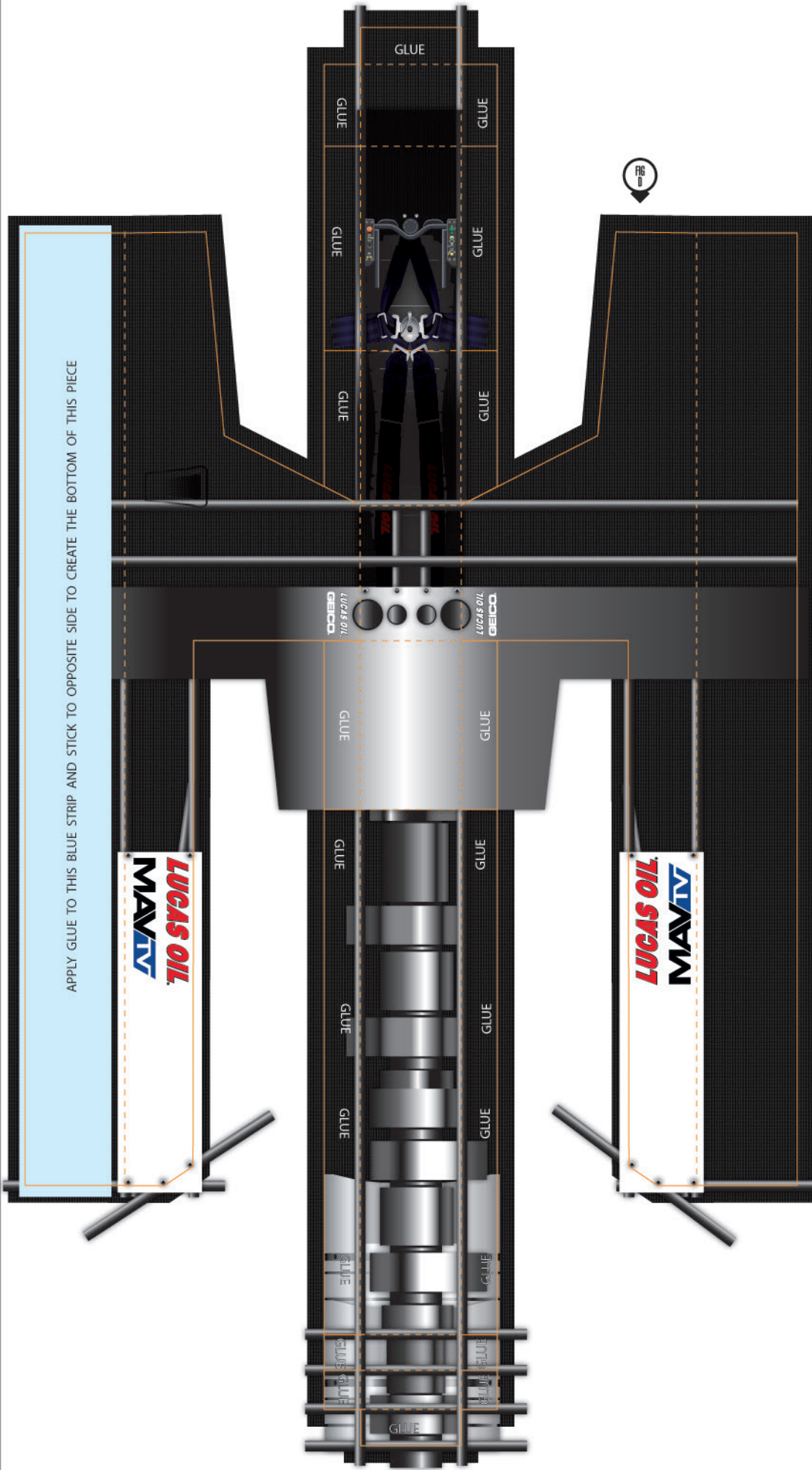



LUCASOIL.COM

BASIC INSTRUCTIONS PG. 3 of 6

- PRINT OUT
- CUT OUT ALONG SOLID LINES AND THEN FOLD ON DOTTED LINES (XACTO KNIFE WORKS BEST)

STEP 8: FOLD AND GLUE THESE SHAPES

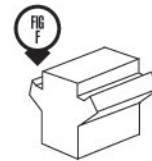

THE SIDES FOR FIG H WILL HAVE A CURVE SHAPE TO THEM WHEN GLED SHUT

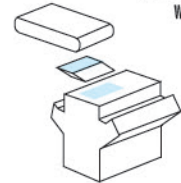

STEP 9: GLUE PIECES TOGETHER APPLY GLUE TO ALL BLUE AREAS

STEP 10: GLUE TO ASSEMBLED PIECE

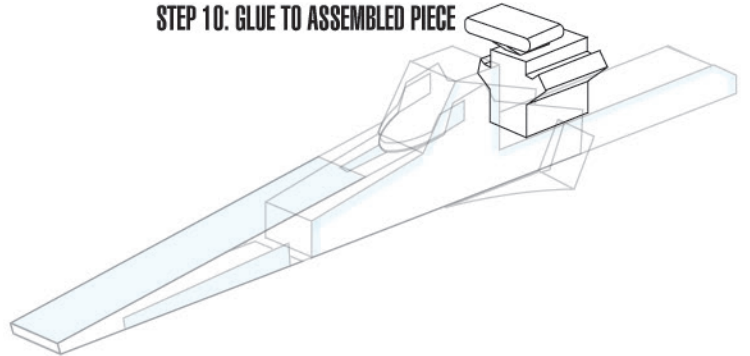

STEP 11: FOLD AND GLUE TOGETHER AND THEN ATTACH TO ASSEMBLED PIECE

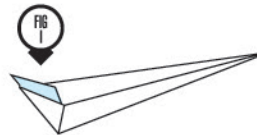

ATTACH GLED FLAP TO ASSEMBLED PIECE

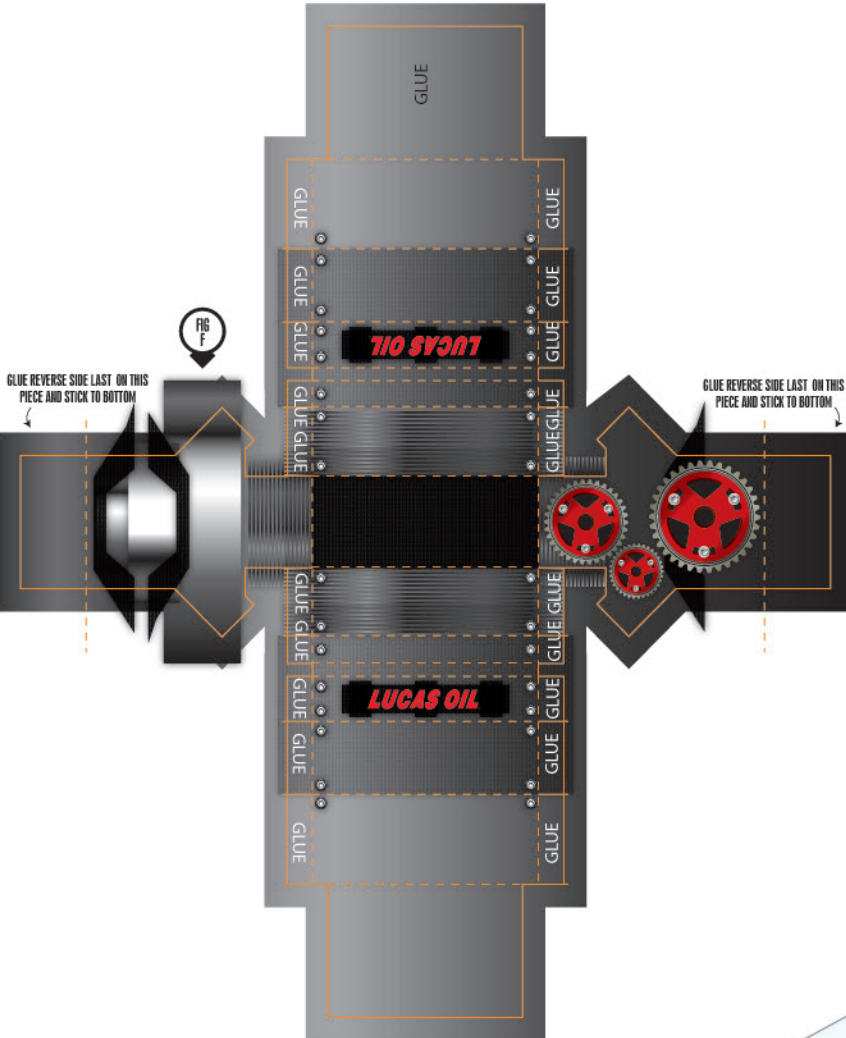
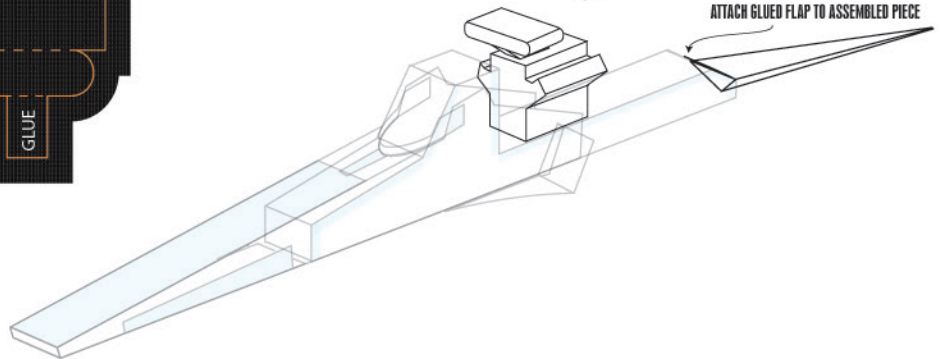

GLUE REVERSE SIDE LAST ON THIS PIECE AND STICK TO BOTTOM

GLUE REVERSE SIDE LAST ON THIS PIECE AND STICK TO BOTTOM

FIG F

FIG H

FIG G

FIG I

FIG I

SHAPE SHOULD FOLD INTO A TRIANGLE WITH A TAB TO BE USED TO ATTACH TO ASSEMBLED PIECE

GLUE REVERSE SIDE LAST AND ATTACH TO ASSEMBLED PIECE

GLUE



LUCASOIL.com

BASIC INSTRUCTIONS PG. 4 of 6

- PRINT OUT
- CUT OUT ALONG SOLID LINES AND THEN FOLD ON DOTTED LINES (XACTO KNIFE WORKS BEST)

THIS WILL BECOME A TAB THAT WILL SLIDE IN TO A SLOT THAT WILL BE CUT IN TO FIG K

GLUE REVERSE SIDE LAST AND FOLD IN HALF ON DOTTED LINE

AFTER TABS ARE SLID IN, GLUE ON REVERSE SIDE AND FOLD IN HALF. TABS FROM FIG K WILL BE SANDWICHED IN BETWEEN.

TABS FROM FIG K WILL SLIDE INTO THESE SLOTS ONCE THEY HAVE BEEN CUT

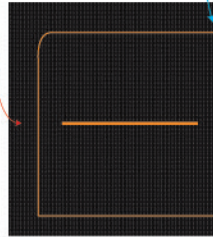

GEICO.



GEICO.



TABS FROM FIG J WILL SLIDE INTO THESE SLOTS ONCE THEY HAVE BEEN CUT

AFTER TABS ARE SLID IN, GLUE ON REVERSE SIDE AND FOLD IN HALF. TABS FROM FIG J WILL BE SANDWICHED IN BETWEEN.



THIS WILL BECOME A TAB THAT WILL SLIDE IN TO A SLOT THAT WILL BE CUT IN TO FIG L

WHEN FOLDED TOGETHER GLUE REVERSE SIDE TO STICK TO WHOLE PIECE



RED MARKS SHOW WHERE TABS WILL BE ONCE THE ARE SANDWICHED IN



STEP 12:

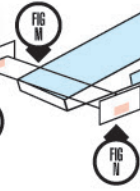

GLUE REVERSE SIDE AND FOLD IN HALF ON DOTTED LINE

THIS WILL BECOME A TAB THAT WILL SLIDE IN TO A SLOT THAT WILL BE CUT IN TO FIG N



TABS FROM FIG N WILL SLIDE INTO THESE SLOTS ONCE THEY HAVE BEEN CUT



AFTER TABS ARE SLID IN, GLUE ON REVERSE SIDE AND FOLD IN HALF. TABS FROM FIG N WILL BE SANDWICHED IN BETWEEN.

THIS WILL BECOME A TAB THAT WILL SLIDE IN TO A SLOT THAT WILL BE CUT IN TO FIG K

GLUE REVERSE SIDE LAST AND FOLD IN HALF ON DOTTED LINE

BASIC INSTRUCTIONS PG. 5 of 6

- PRINT OUT
- CUT OUT ALONG SOLID LINES AND THEN FOLD ON DOTTED LINES (XACTO KNIFE WORKS BEST)

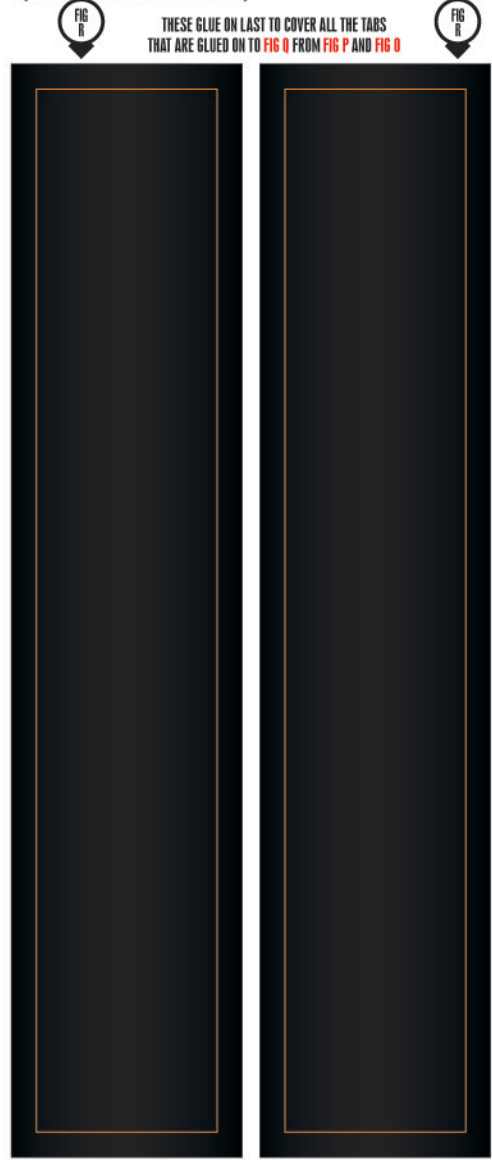
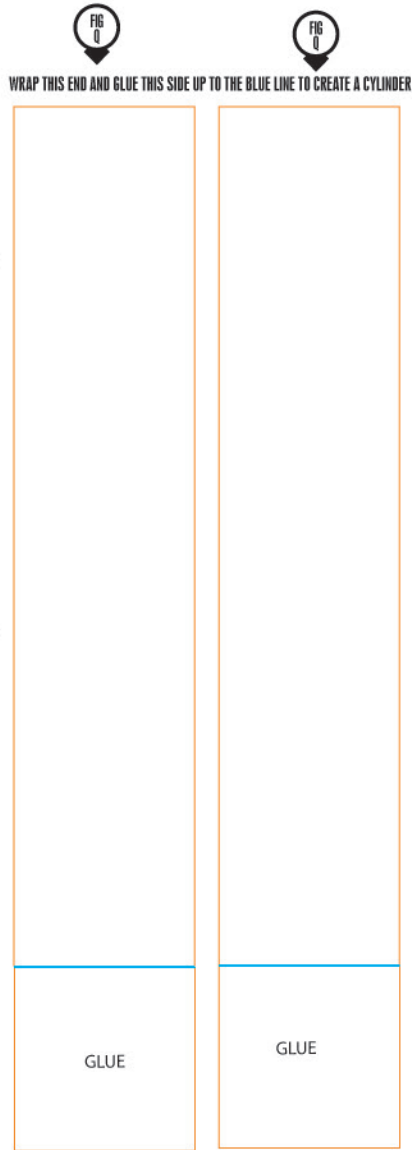
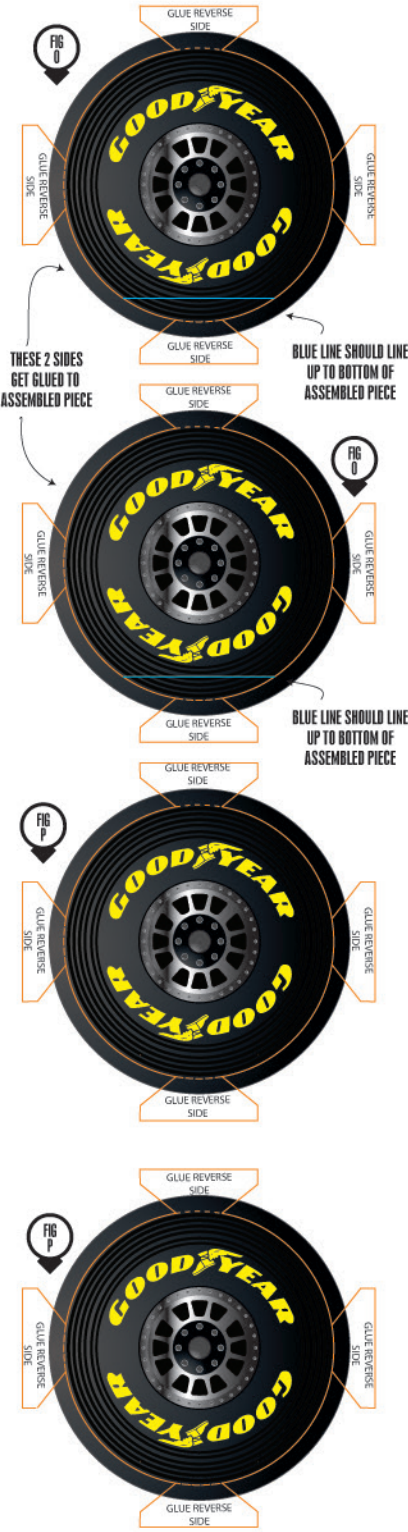

STEP 13: ASSEMBLE BACK WHEELS

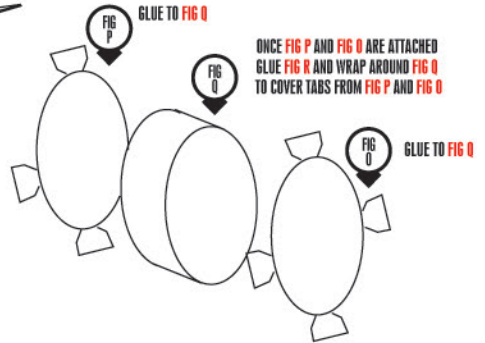
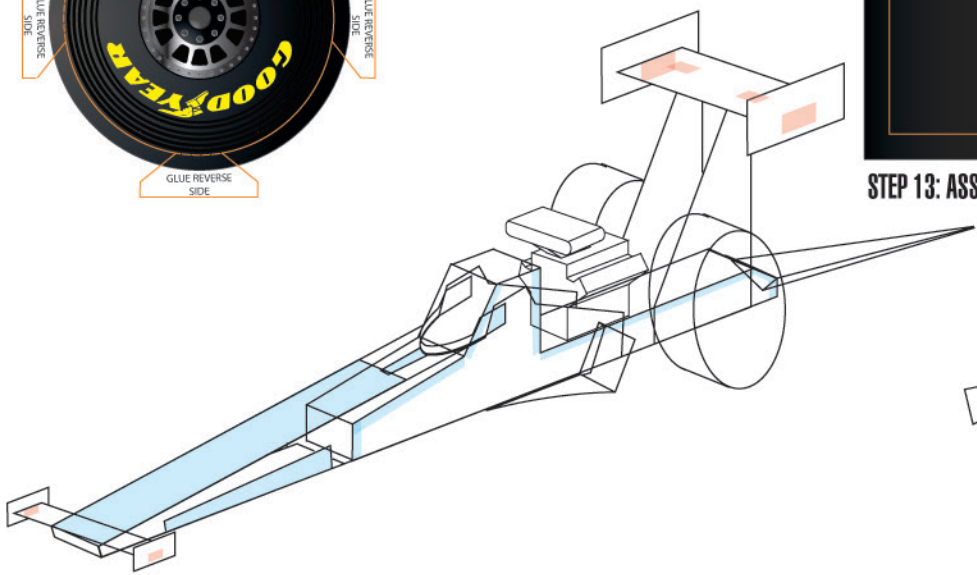

BASIC INSTRUCTIONS PG. 6 of 6

- PRINT OUT
 - CUT OUT ALONG SOLID LINES AND THEN FOLD ON DOTTED LINES (XACTO KNIFE WORKS BEST)
- STEP 14: ASSEMBLE FRONT WHEELS (SAME PROCEDURE AS BACK WHEELS)

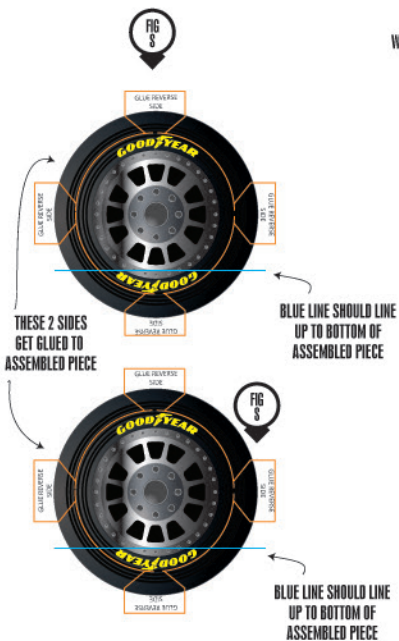

WRAP THIS END AND GLUE THIS SIDE UP TO THE BLUE LINE TO CREATE A CYLINDER

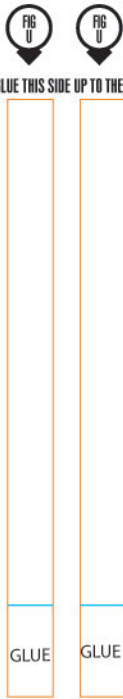

THESE GLUE ON LAST TO COVER ALL THE TABS THAT ARE GLUED ON TO FIG U FROM FIG S AND FIG T

